

Frame Code (JMS)  
JAMES



**Standard Features:**

- Advanced unidirectional suspension system
- Premium high-density, high-resiliency foam seat cushions
- Loose back and seat cushions
- Single-needle top-stitch
- Lifetime warranty on frame and suspension
- Quick-ship delivery

**Options:**

- Contrasting stitch detail available in Black, Brown, Charcoal, Cream, Espresso, Grey, Lemon, Pink, Royal, Scarlet, Tangerine, or Teal thread color
- Choice of decorative stitch detail - blanket, cross, double-needle, or zig-zag
- Wood legs available in Acorn, Espresso or Walnut finish

Please use actual leather, fabric, Crypton®, Sunbrella® and Ultrasuede® swatches when specifying furniture as the colors shown may vary due to the printing process.

**Decorative Stitches Available:**

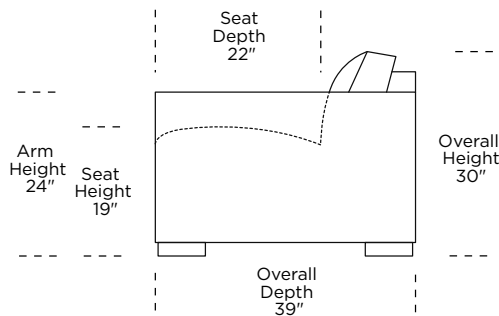
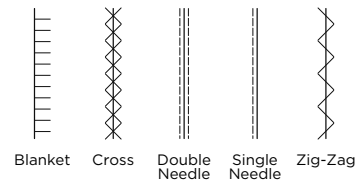

**Note:** Dotted line indicates seam on leather, Ultrasuede® and up the roll fabrics. Seams are eliminated with railroaded fabrics.

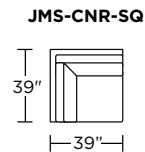
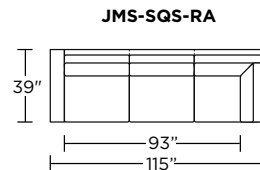
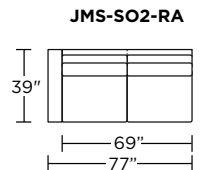
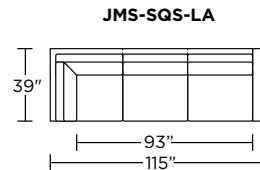
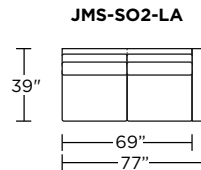
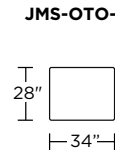
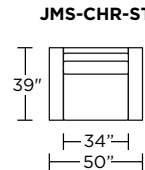
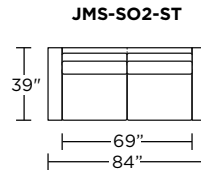
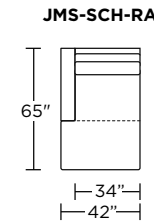
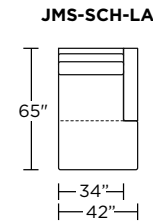
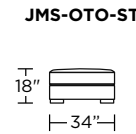
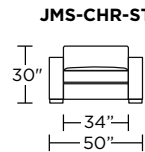
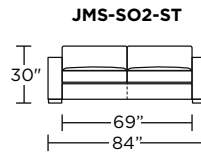

Scale: 1/8 inch = 1 foot  
All dimensions are approximate and subject to change.  
Specify components from the sitting position.

V.11.25.19